

Ihr sicherer Gewinn

Formgebung, Bauart

Platzsparend dank kompakter Bauart
Hohe Positioniergenauigkeit
Stabilität und Belastbarkeit durch
spielfreie Nadellagerführungen
Hundertprozentige Reproduzierbarkeit dank
formschlüssigem Aufbau

Hubeinstellung, Überwachung

Einfaches und schnelles Einrichten dank Hubjustierung
unter Druck
Kein Nachjustieren der Sensoren
Hohe Verfügbarkeit durch einfachen Austausch
handelsüblicher Sensoren im Servicefall

Kombinationsmöglichkeiten

Minimaler Konstruktions- und Montageaufwand dank
durchdachtem System und einheitlichem Rastermass

Your definitive gain

Style, Design

Space-saving thanks to compact design
High positioning accuracy, stability and load
carrying capacity through the use of zero-play, double
guided carriages with needle roller bearings
One-hundred percent reproducibility thanks to positive
interlocking design

Travel Adjustment, Monitoring

Simple and fast setup thanks to travel adjustment under
pressure
No readjustment of the sensors
High availability due to easy exchange of commercial
sensors in the event of service

Combination Options

Minimal construction and assembly work thanks to well
thought out system and uniform grid spacing

Linearmodule | Linear Modules

Technische Daten – Zusammenfassung FE-Baureihe | Technical Data – Summary FE Series

		elektrisch Electric								
		LM 4 SE			LM 6 FE			LM 8 FE		
		SE-30	SE-60	SE-90	FE-90	FE-180	FE-270	FE-60	FE-120	FE-240
Hublängen [mm]: h Stroke lengths [mm]: h	0-30									
	0-60									
	0-90									
	0-120									
	0-180									
	0-240									
	0-270									
Theor. Kraft Fa/Fb [N]: Theor. force Fa/Fb [N]:	47/47									
	110/110									
	440/440									
Max. zulässige Masse [kg]: Max. permissible mass [kg]:	2									
	5									
	20									
Gewicht [kg]: Weight [kg]:		1,1	1,2	1,3	3,3	3,9	4,4	5,6	7,0	8,5
Angriffspunkt für alle Momente [mm]: Point of application of force for all torques [mm]:	M	55	70	85	110	110	110	138	170	170
Max. statische Momente [Nm]: Maximum static torques [Nm]:	Ma	10	20	20	370	370	370	386	386	386
	Mb	10	20	20	370	370	370	784	784	784
	Mc	30	30	30	63	63	63	336	336	336
Wiederholgenauigkeit [mm]: Repeat accuracy [mm]:		±0,01	±0,01	±0,01	±0,01	±0,01	±0,01	±0,01	±0,01	±0,01

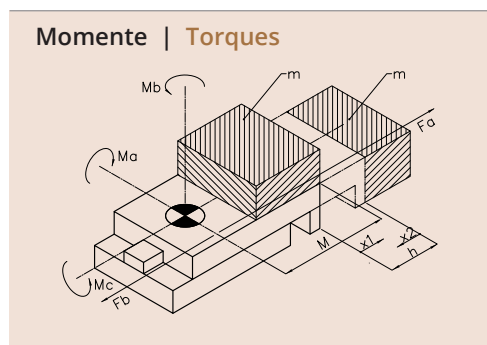

* Für Berechnungen gilt: $M_a/M_{a \max} + M_b/M_{b \max} + M_c/M_{c \max} < 1$
 * Bei Belastungen die während der Fahrt des Schlittens auftreten ist $M_{\max} = 20\% M_{\max \text{ statisch}}$ einzusetzen

* This applies to calculations: $M_a/M_{a \max} + M_b/M_{b \max} + M_c/M_{c \max} < 1$
 * For stresses during the drive of the carriage $M_{\max} = 20\% M_{\max \text{ static}}$

Längsbelastung

Die Grafik zeigt die Auslenkung f des Schlittens unter der Einwirkung der Kraft F .

Axial Load

The graph shows the deflection f of the slide under the effect of the force F .

Querbelastung

Die Grafik zeigt die Auslenkung f des Schlittens unter der Einwirkung der Kraft F .

Transverse Load

The graph shows the deflection f of the slide under the effect of the force F .

Seitenbelastung

Die Grafik zeigt die Auslenkung des Schlittens bei Punkt A unter Einwirkung des Moments.

Lateral Load

The graph shows the deflection f of the slide at point A under the effect of the torque.

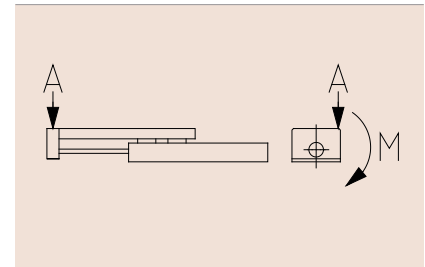
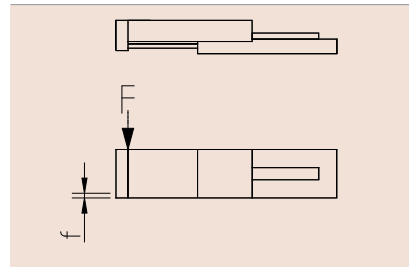
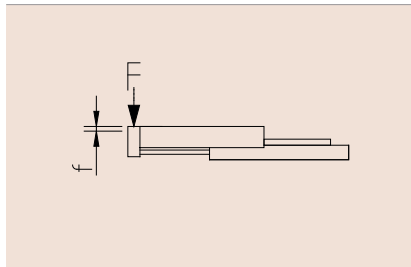

LM 4 SE

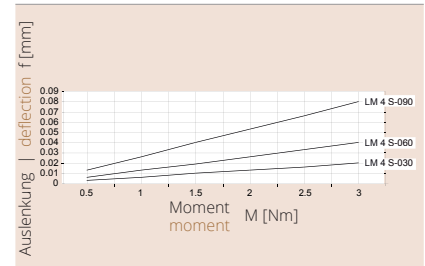
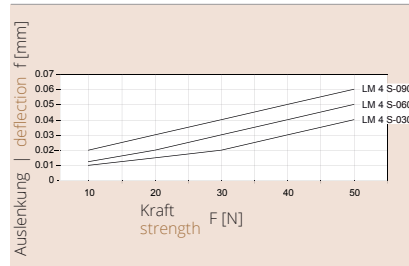
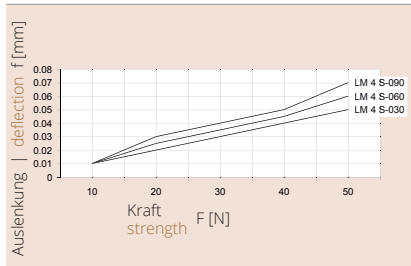

LM 6 FE

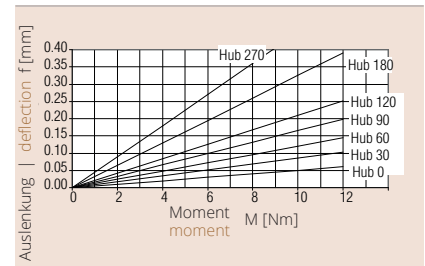
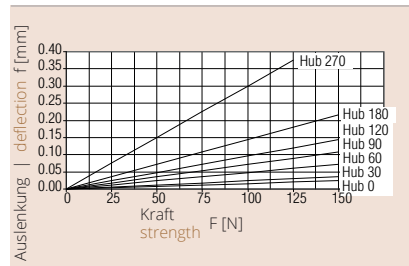
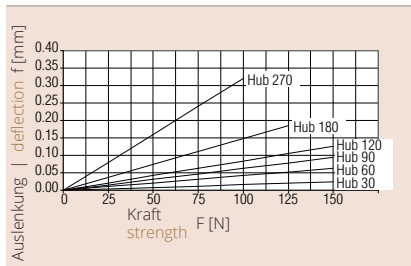

LM 8 FE

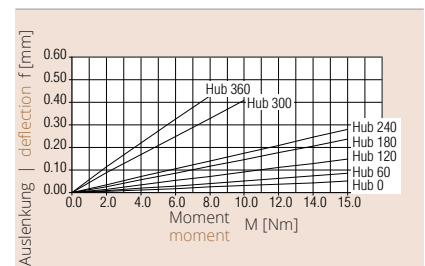
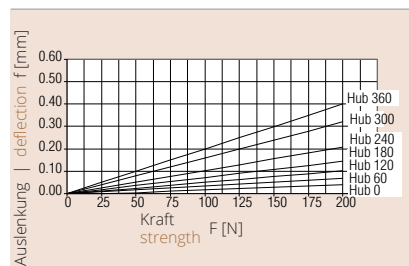
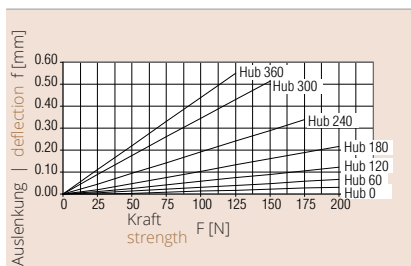

Linearmodule | Linear Modules

LM 6 FE – elektrisches Linearmodul | LM 6 FE – Electrical Linear Module

LM 6 FE

Elektrische Anschlüsse | Electrical Connections

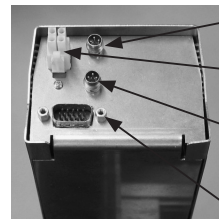

- Bremse (M8 x 1 / 3 Pol)
Brake (M8 x 1 / 3 Pole)
- Motorleistung (Mini-U-MNL 4 POL AMP)
Motor output (Mini-U-MNL 4 POLE AMP)
- Referenzsensor (M8 x 1 / 3 Pol)
Reference sensor (M8 x 1 / 3 Pole)
- Motor Comcoder
Motor Comcoder

Technische Daten, hubunabhängig	Technical Data, stroke-independent	
Kugelspindel Steigung	Spherical spindle lead	Ø 10x10 mm
Übersetzung Zahnriemen	Toothed belt ratio	1:1,25
Hub pro Motorumdrehung	Travel per motor revolution	8 mm
theor. Kraft Fa/Fb	Theor. force Fa/Fb	110 N
theor. zulässige Kraft Fa/Fb	Theor. permissible force Fa/Fb	350 N
max. Geschwindigkeit (LM 6 FE-270)	Max. speed (LM 6 FE-270)	0,75 m/s (0,5 m/s)
max. Beschleunigung	Max. acceleration	10 m/s ²
<hr/>		
Servomotor*	Servomotor*	AKM 12C
Motor Nennleistung	Motor nominal output	230 W
Nenn Drehmoment	Nominal torque	0,28 Nm
Stillstands Drehmoment	Static torque	0,31 Nm
Stillstandstrom	Standstill current	1,51 A
Spitzenstrom	Peak current	6,06 A
Elektrischer Anschluss	Electrical connection	230 V AC
Encoder	Encoder	2048 Inc
Bremse	Brake	24 V DC, 5 W
<hr/>		
Temperaturbereich	Temperature range	0 – 60°C
Wiederholgenauigkeit	Repeat accuracy	-/+ 0,01 mm
max. zulässige Masse	Max. permissible mass	5 kg
*weitere Motorvarianten auf Anfrage möglich	*Inquiry for other motors	
Technische Daten, hubabhängig	Technical data, stroke-dependent	
Siehe Seite 56	See page 56	

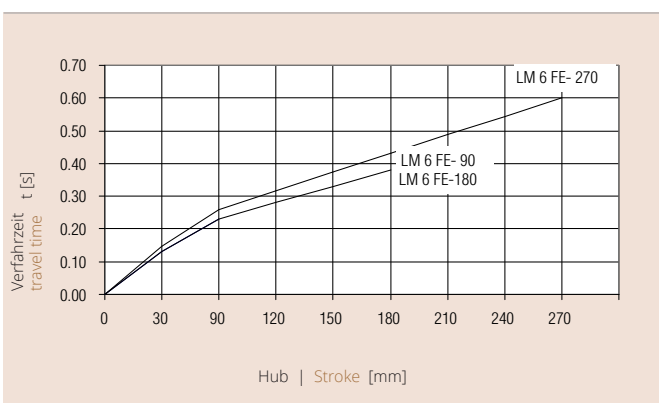

Zulässige Verfahzeit

Die aus dem Diagramm ermittelte Verfahzeit t darf nicht unterschritten werden.

Permissible travel time

The travel time t determined from the diagram may not be undershot.

Linearmodule | Linear Modules

LM 6 FE – elektrisches Linearmodul | LM 6 FE – Electrical Linear Module

Massbild | Dimensional drawing

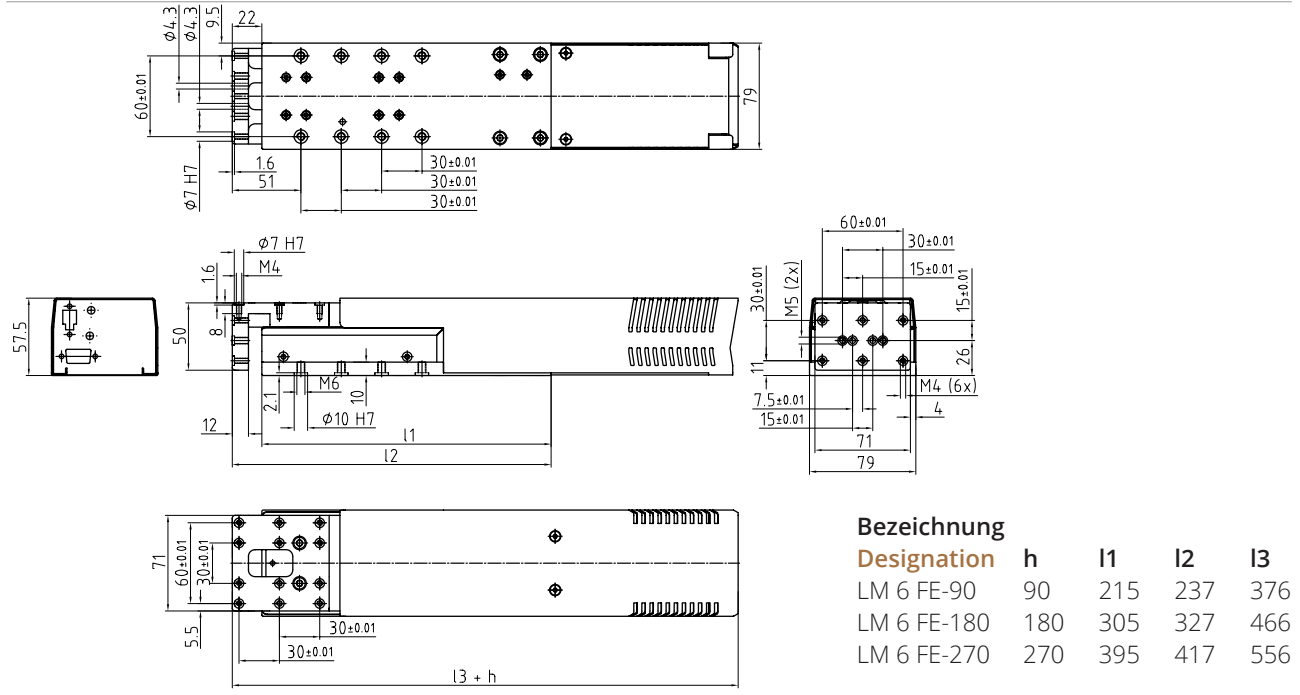

Bezeichnung	Designation	Bestellnr.	Order no.
LM 6 FE-90 C		300 8869	
LM 6 FE-180 C		300 8804	
LM 6 FE-270 C		300 8859	
LM 6 FE-90 CB inkl. Haltebremse	incl. holding brake	300 8871	
LM 6 FE-180 CB inkl. Haltebremse	incl. holding brake	300 8851	
LM 6 FE-270 CB inkl. Haltebremse	incl. holding brake	300 8861	
LM 6 FE-90 R		300 9686	
LM 6 FE-180 R		300 9682	
LM 6 FE-270 R		300 9684	
LM 6 FE-90 RB inkl. Haltebremse	incl. holding brake	300 9688	
LM 6 FE-180 RB inkl. Haltebremse	incl. holding brake	300 9683	
LM 6 FE-270 RB inkl. Haltebremse	incl. holding brake	300 9685	
inkl. 4 Zentrierringe Ø 10	incl. 4 Centering rings Ø 10		

Zubehör	Accessories
Referenzeinheit	Reference unit 300 9513
Schleppkettenkabel Motor 5m / 10m	Drag chain cable Motor 5m / 10m 300 9514 / 300 9671
Schleppkettenkabel Comcoder 5m / 10m	Drag chain cable Comcoder 5m / 10m 300 9512 / 300 9672
Schleppkettenkabel Resolver 5m / 10m	Drag chain cable Resolver 5m / 10m 300 9725 / 300 9726
Zentrierring Ø 7	Centering ring Ø 7 300 1521
Zentrierring Ø 10	Centering ring Ø 10 300 1522
Endschalter 8x8	Limit switch 8x8 301 5214
Sensor Induktiv M8x1	Limit switch M8x1 301 4955

Lieferumfang | Scope of supply



Lieferumfang Zubehör | Scope of supply external

