

Ihr sicherer Gewinn

Formgebung, Bauart

Platzsparend dank kompakter Bauart
Hohe Positioniergenauigkeit
Stabilität und Belastbarkeit durch
spielfreie Nadellagerführungen
Hundertprozentige Reproduzierbarkeit dank
formschlüssigem Aufbau

Hubeinstellung, Überwachung

Einfaches und schnelles Einrichten dank Hubjustierung
unter Druck
Kein Nachjustieren der Sensoren
Hohe Verfügbarkeit durch einfachen Austausch
handelsüblicher Sensoren im Servicefall

Kombinationsmöglichkeiten

Minimaler Konstruktions- und Montageaufwand dank
durchdachtem System und einheitlichem Rastermass

Your definitive gain

Style, Design

Space-saving thanks to compact design
High positioning accuracy, stability and load
carrying capacity through the use of zero-play, double
guided carriages with needle roller bearings
One-hundred percent reproducibility thanks to positive
interlocking design

Travel Adjustment, Monitoring

Simple and fast setup thanks to travel adjustment under
pressure
No readjustment of the sensors
High availability due to easy exchange of commercial
sensors in the event of service

Combination Options

Minimal construction and assembly work thanks to well
thought out system and uniform grid spacing

Linearmodule | Linear Modules

Technische Daten – Zusammenfassung S-Baureihe | Technical Data – Summary S-Series

		pneumatisch Pneumatic									
		LM 4 S			LM 5 S			LM 6 S			
		S-30	S-60	S-90	S-60	S-90	S-120	S-60	S-120	S-180	S-240
Hublängen h [mm]: Stroke lengths h [mm]:	0-30										
	0-60										
	0-90										
	0-120										
	0-180										
	0-240										
Theor. Kraft (bei 5 bar) Fa/Fb [N]: Theor. force (at 5 bar) Fa/Fb [N]:	100/86										
	157/131										
	245/206										
Max. zulässige Masse [kg]: Max. permissible mass [kg]:	2										
	4										
	6										
Zylinderdurchmesser [mm]: Cylinder diameter [mm]:	1x16										
	1x20										
	1x25										
Luftverbrauch pro Zyklus bei 5 bar und Nennhub [NI]: Air consumption per cycle at 5 bar and nominal stroke [NI]:		0.06	0.12	0.18	0.2	0.3	0.4	0.3	0.6	0.9	1.2
Gewicht [kg]: Weight [kg]:		0.6	0.7	0.8	1.2	1.4	1.5	2.0	2.6	3.2	3.8
Angriffspunkt für alle Momente [mm]: Point of application of force for all torques [mm]:	M	55	70	85	75	90	100	100	130	160	200
Max. statische Momente [Nm]: Maximum static torques [Nm]:	Ma	10	20	20	25	25	25	60	60	80	100
	Mb	10	20	20	25	25	25	60	60	80	100
	Mc	30	30	30	80	80	80	100	100	100	120
Anschlag vorne Verstellbereich [mm]: Front stop range of adjustment [mm]:	x2	0-30	0-60	0-90	0-60	0-90	0-120	0-60	0-120	0-180	0-240
Anschlag hinten Verstellbereich [mm]: Rear stop range of adjustment [mm]:	x1	0-30	0-30	0-30	0-40	0-40	0-40	0-30	0-60	0-60	0-60
Wiederholgenauigkeit [mm]: Repeat accuracy [mm]:		±0,01	±0,01	±0,01	±0,01	±0,01	±0,01	±0,01	±0,01	±0,01	±0,01
Pneumatikanschluss Pneumatic connection		M 5	M 5	M 5	M 5	M 5	M 5	G1/8	G1/8	G1/8	G1/8

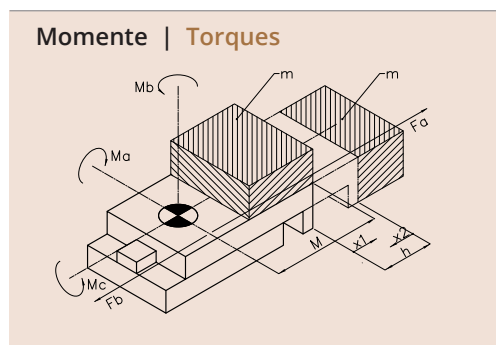

* Für Berechnungen gilt: $M_a/M_{a \max} + M_b/M_{b \max} + M_c/M_{c \max} < 1$
 * Bei Belastungen die während der Fahrt des Schlittens auftreten ist $M_{\max} = 20\% M_{\max \text{ statisch}}$ einzusetzen

* This applies to calculations: $M_a/M_{a \max} + M_b/M_{b \max} + M_c/M_{c \max} < 1$
 * For stresses during the drive of the carriage $M_{\max} = 20\% M_{\max \text{ static}}$

Längsbelastung

Die Grafik zeigt die Auslenkung f des Schlittens unter der Einwirkung der Kraft F bei max. Hub.

Axial Load

The graph shows the deflection f of the slide under the effect of the force F at maximum Stroke.

Querbelastung

Die Grafik zeigt die Auslenkung f des Schlittens unter der Einwirkung der Kraft F bei max. Hub.

Transverse Load

The graph shows the deflection f of the slide under the effect of the force F at maximum Stroke.

Seitenbelastung

Die Grafik zeigt die Auslenkung des Schlittens bei Punkt A unter Einwirkung des Moments bei max. Hub.

Lateral Load

The graph shows the deflection f of the slide at point A under the effect of the torque by maximum Stroke.

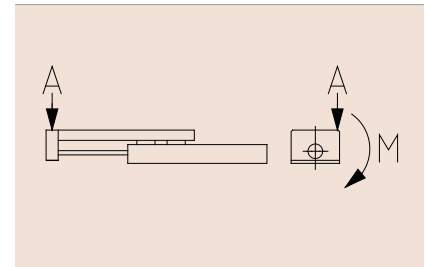
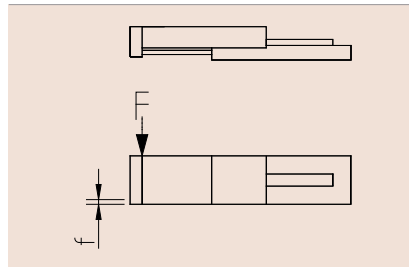
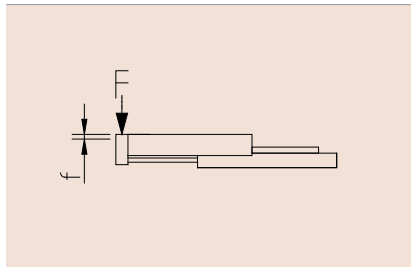

LM 4 S

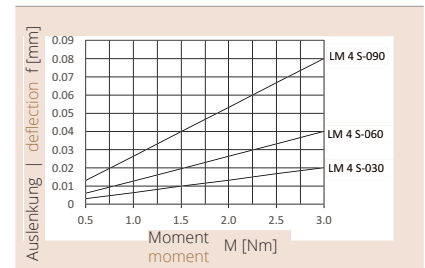
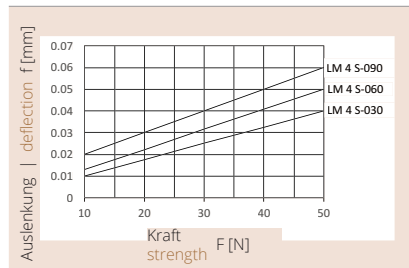
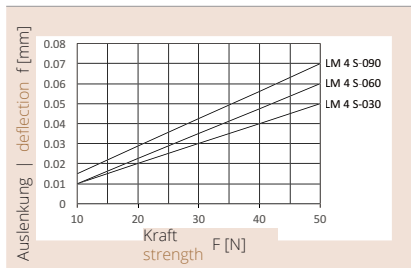

LM 5 S

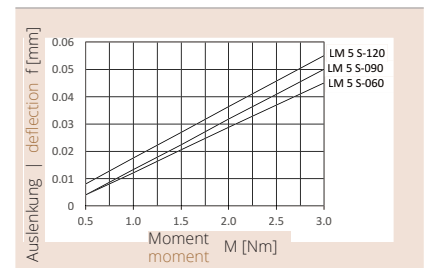
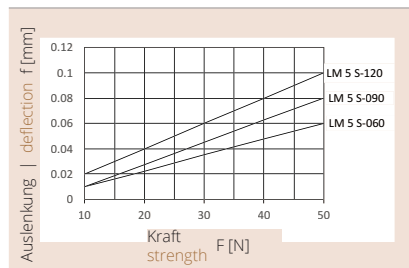
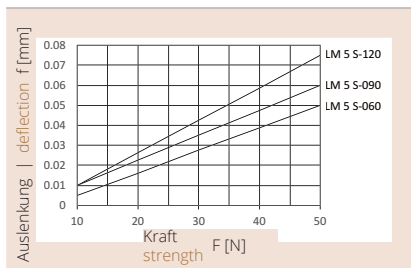

LM 6 S

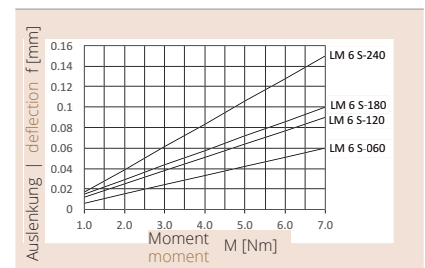
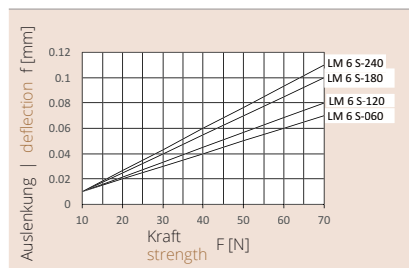
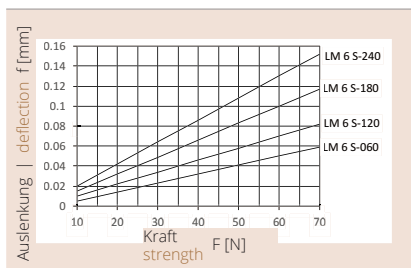

Linearmodule | Linear Modules

LM 4 S – pneumatisches Linearmodul | LM 4 S – Pneumatic Linear Module

LM 4 S

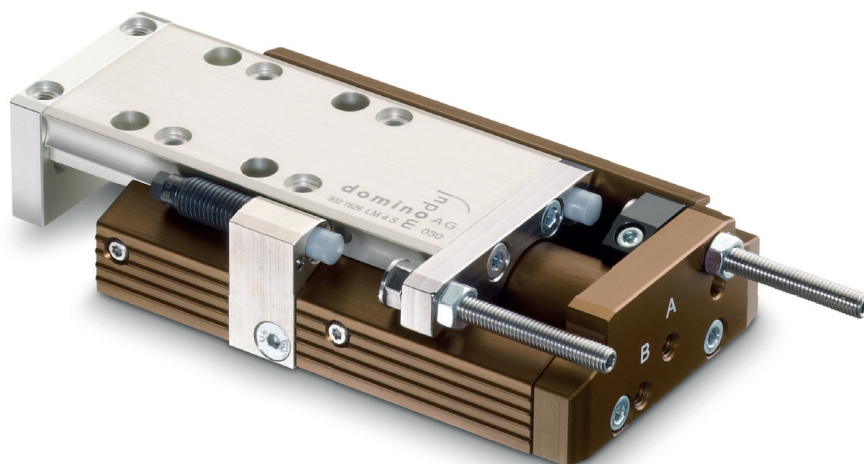

Technische Daten, hubunabhängig | Technical data, stroke-independent

Zylinderdurchmesser	Cylinder diameter	1 x Ø16 mm
theor. Kraft (bei 5 bar) Fa/Fb	Theor. force (at 5 bar) Fa/Fb	100 N/86 N
max. Geschwindigkeit	Max. speed	0,5 m/s
Pneumatikanschlüsse	Pneumatic connections	M5
Medium Druckluft	Medium Compressed-air	trocken gefiltert dry filtered
Betriebsdruckbereich	Operating pressure range	3 – 7 bar
Temperaturbereich	Temperature range	0 – 60°C
Wiederholgenauigkeit	Repeat accuracy	+/-0.01 mm
max. zulässige Masse	Max. permissible mass	2 kg

Technische Daten, hubabhängig | Technical data, stroke-dependent
 Siehe Seite 36 | See page 36

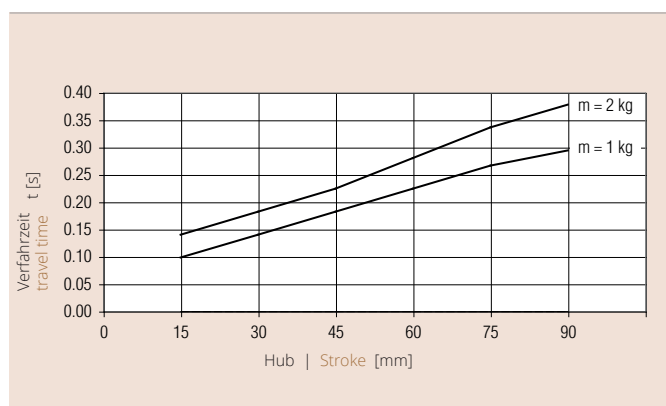

Zulässige Verfahrzeit t in Abhängigkeit der Hublänge und der Zusatzmasse m

Die aus dem Diagramm ermittelte Verfahrzeit t darf nicht unterschritten werden, diese ist ohne Ventilschaltzeit bei Nenn- druck 6 bar gemessen. Empfehlung: Bei Auslegung der Achse sollte die Verfahrzeit t um 20% erhöht angenommen werden.

Permissible travel time t relative to the stroke length and the additional mass m

The travel time t determined from the diagram may not be exceeded this is measured without valve switching time at nominal pressure 6 bar. Recommendation: During the design of the axis, the travel time t should be assumed to be about 20% more.

Linearmodule | Linear Modules

LM 4 S – pneumatisches Linearmodul | LM 4 S – Pneumatic Linear Module

Massbild und Pneumatikschema | Dimensional drawing and pneumatic diagram

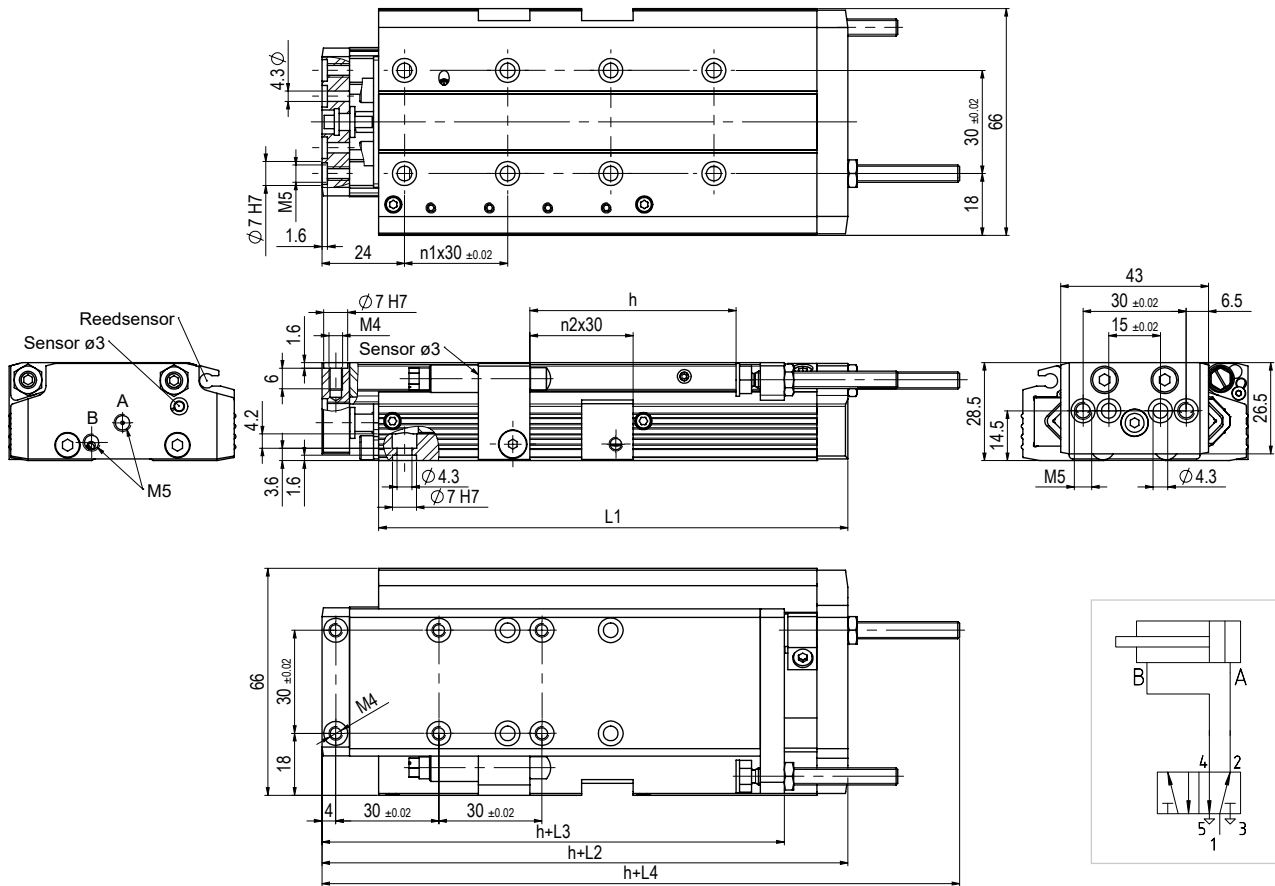

Bezeichnung

Designation	h	L1	L2	L3	L4	n1	n2
LM 4 S-30	30	107.0	123.5	105.0	156.0	2	0
LM 4 S-60	60	136.5	153.0	134.5	185.5	3	1
LM 4 S-90	90	171.0	187.5	169.0	220.0	4	2

Bezeichnung	Designation	Bestellnr.	Order no.
LM 4 S-030		302 1626	
LM 4 S-060		302 1610	
LM 4 S-090		302 1585	
inkl. hydraulische Stosdämpfer und 4 Zentrierringe Ø 7	Incl. hydraulic shock absorber and 4 Centering ringe Ø 7		

Zubehör	Accessories	Bestellnr.	Order no.
Zentrierring Ø 7	Centering ring Ø 7	300 1521	
Endschalter Ø 3	Limit switch Ø 3	300 3162	
Endschalter Reed für Nute	Reed switch for flute	300 1288	
Zentrierkupplung ZK 5/6	Centering coupling ZK 5/6	300 2478	
Stosdämpfer	Shock absorber	300 1386	