

Ihr sicherer Gewinn

Formgebung, Bauart

Platzsparend dank kompakter Bauart, klare geometrische Form, keine vorstehenden Kanten.
Einfacher Aufbau von Portalkombinationen dank frei wählbarer Länge des Grundprofils.
Hundertprozentige Reproduzierbarkeit dank formschlüssigem Aufbau.

Hubeinstellung, Überwachung

Flexibler Einsatz und hohe Wiederverwendbarkeit, da jeder beliebige Hub im Hubbereich einstellbar.
Einfaches und schnelles Einrichten dank Hubjustierung unter Druck, kein Nachjustieren der Sensoren. Hohe Verfügbarkeit durch einfachen Austausch handelsüblicher Sensoren im Servicefall.

Modular

Minimaler Konstruktions- und Montageaufwand dank durchdachtem System und einheitlichem Rastermass.

Your definitive gain

Style, Design

Space-saving, thanks to compact design, simple geometric form, no protruding edges.
Simple assembly of portal combinations, thanks to freely selectable length of the base profile.
One-hundred percent reproducibility, thanks to positive interlocking design.

Travel Adjustment, Monitoring

Flexible usage and high reusability, since every optional stroke within the range of travel can be set.
Simple and fast setup, thanks to travel adjustment under pressure, no readjustment of the sensors.
High availability due to easy exchange of commercial sensors in the event of service.

Modular

Minimal construction and assembly work required, thanks to well thought out system and uniform grid spacing.

Linearachsen | Linear Axes

Technische Daten – Zusammenfassung | Technical Data – Summary

			Pneumatische Achsen Pneumatic Axes				Elektrische Achsen Electrical Axes				
			LM 6 P	LM 8 P	LM 8 PV	LM 10 P	LM 6 PE	LM 8 PE	LM 8 PEV	LM 10 PE	
Standard Hublängen h [mm]: Standard stroke lengths h [mm]: Gesamtlänge [mm]: Overall length [mm]:	L	0-150	408	468	468	558	483	543	543	543	
		0-270	528	588	588	678	603	663	663	663	
		0-390	648	708	708	798	723	783	783	783	
		0-510	768	828	828	918	843	903	903	903	
		0-630	888	948	948	1038	963	1023	1023	1023	
		0-750	1008	1068	1068	1158	1083	1143	1143	1143	
		0-990				1398	1323	1383	1383	1383	
		0-1230				1638	1563	1623	1623	1623	
Hublänge max. [mm]: Stroke length max. [mm]:			3720	3660	3660	3570	3720	3660	3585	3585	
Gesamtlänge max. [mm]: Overall length max. [mm]:			3978	3978	3978	3978	4053	4053	4053	4053	
Zylinderdurchmesser [mm]: Cylinder diameter [mm]:			18	25	25	25					
Zwischenpositionen [-]: Intermediate positions [-]:											
Theor. Kraft Fa/Fb [N]: (bei 5bar)		126/126									
Theor. force Fa/Fb [N]: (at 5 bar)		245/245									
Theor. zulässige Kraft Fa/Fb [N]: Theor. permissible force Fa/Fb [N]:							540	900	900	900	
Maximale statische Momente [Nm]:		Ma	96	400	400	950	96	400	400	950	
Maximum static orques [Nm]:		Mb	96	400	400	950	96	400	400	950	
		Mc	64	192	560	480	64	192	560	480	
Wiederholgenauigkeit [mm]: Repeat accuracy [mm]:			+/- 0,02	+/- 0,02	+/- 0,02	+/- 0,02	+/- 0,1	+/- 0,1	+/- 0,1	+/- 0,1	
Max. zulässige Masse [kg]: Max. permissible mass [kg]:			4	8	16	16	4	8	16	16	
Gewicht [kg]: Torques [kg]:			0-150	4,1	7,6	9,8	11,0	4,1	8,2	10,2	12,5
			0-270	5,0	9,4	12,1	13,0	4,7	9,7	12,1	13,3
			0-390	5,9	11,2	14,3	15,0	5,4	11,2	14,1	15,0
			0-510	6,8	13,0	16,6	17,0	6,0	12,7	16,1	16,7
			0-630	7,7	14,8	18,8	19,0	6,6	14,2	18,1	18,4
			0-750	8,7	16,6	21,1	21,0	7,3	15,7	20,0	20,1
			0-990	9,8	18,2	23,7	25,0	8,5	18,7	24,0	23,6
			0-1230	11,4	19,8	25,3	29,0	9,8	21,7	28,0	27,0
Luftverbrauch pro Zyklus bei 5bar und Nennhub [NI]: Air consumption per cycle at 5 bar and nominal stroke [NI]:			0-150	0,45	0,80	0,80	0,80				
			0-270	0,78	1,45	1,45	1,45				
			0-390	1,12	2,10	2,10	2,10				
			0-510	1,46	2,75	2,75	2,75				
			0-630	1,79	3,40	3,40	3,40				
			0-750	2,13	4,05	4,05	4,05				
			0-990				5,35				
			0-1230				6,65				
Pneumatikanschlüsse: Pneumatic connections:			G1/8"	G1/8"	G1/8"	G1/8"					

Linearachsen | Linear Axes

Technische Daten – Belastungsdiagramme | Technical Data – Load Diagrams

Längsbelastung | Axial Load

Die Grafik zeigt die Auslenkung f des Schlittens im Punkt A (Hebelarm 100 mm) unter Einwirkung des Momentes M_a .

The graph shows the deflection f of the slide at point A (lever arm 100 mm) under the effect of the torque M_a .

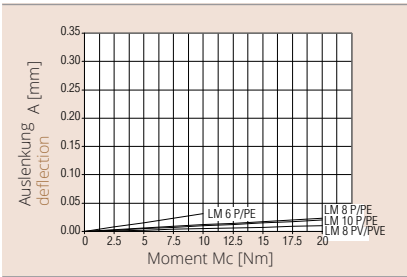
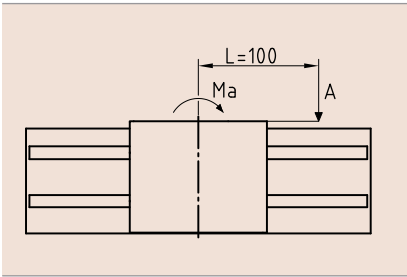

Querbelastung | Transverse Load

Die Grafik zeigt die Auslenkung f des Schlittens im Punkt A (Hebelarm 100 mm) unter Einwirkung des Momentes M_b .

The graph shows the deflection f of the slide at point A (lever arm 100 mm) under the effect of the torque M_b .

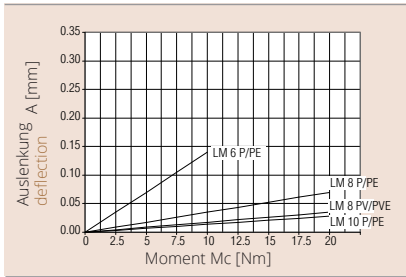
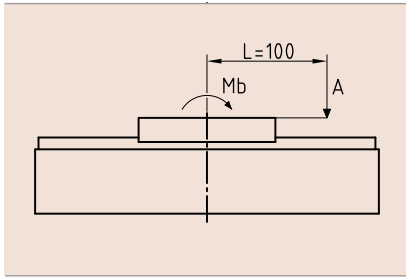

Seitenbelastung | Lateral Load

Die Grafik zeigt die Auslenkung f des Schlittens im Punkt A (Hebelarm 100 mm) unter Einwirkung des Momentes M_c .

The graph shows the deflection f of the slide at point A (lever arm 100 mm) under the effect of the torque M_c .

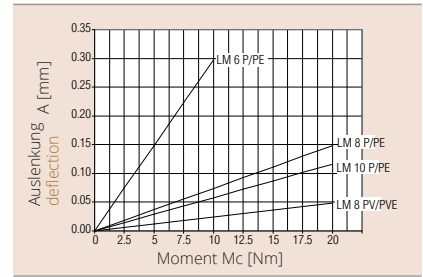
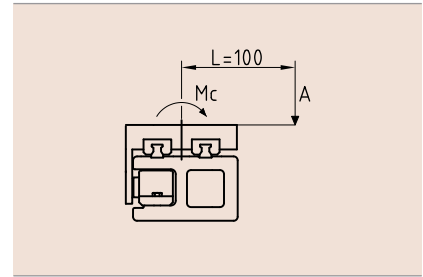

Biegekennlinien | Bending characteristics

Das Diagramm zeigt die Durchbiegung des Aluminiumprofils, Lastfall statisch

The diagram shows the sagging of the aluminium profile, static loading

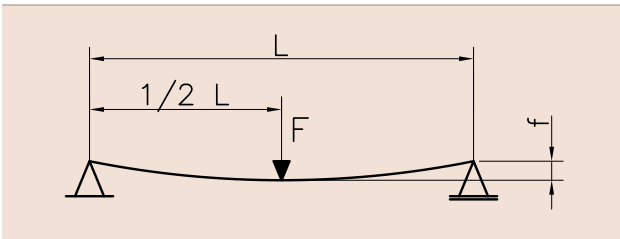

Momente Achse Torques Axis

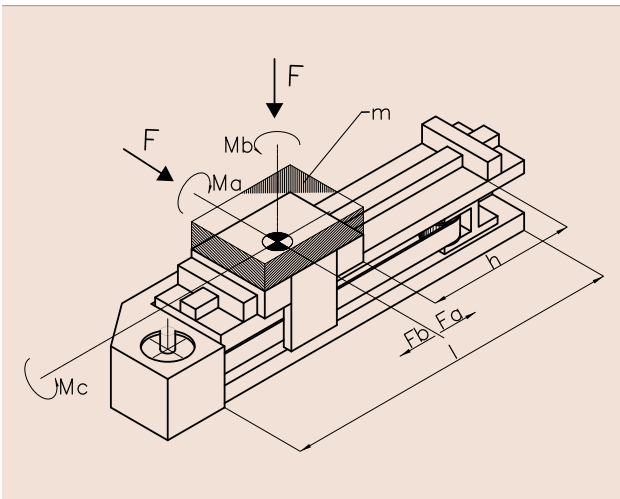

LM 6 P / LM 6 PE

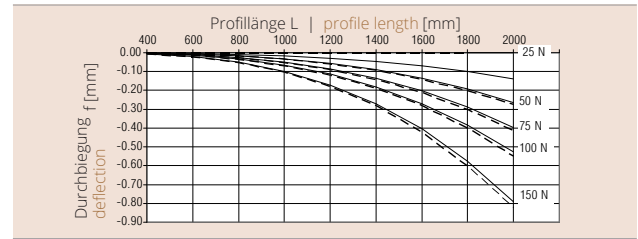

LM 8 P / LM 8 PV / LM 8 PE / LM 8 PEV

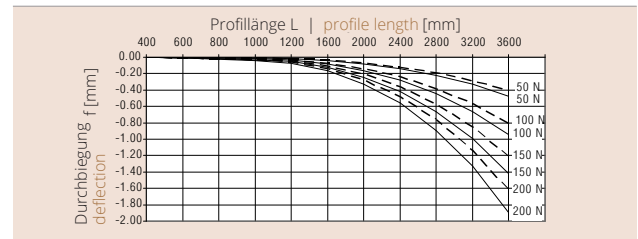

LM 10 P / LM 10 PE

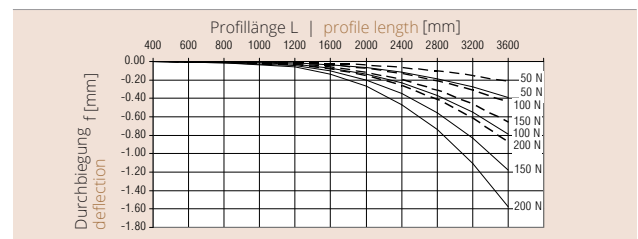

LM 8 P

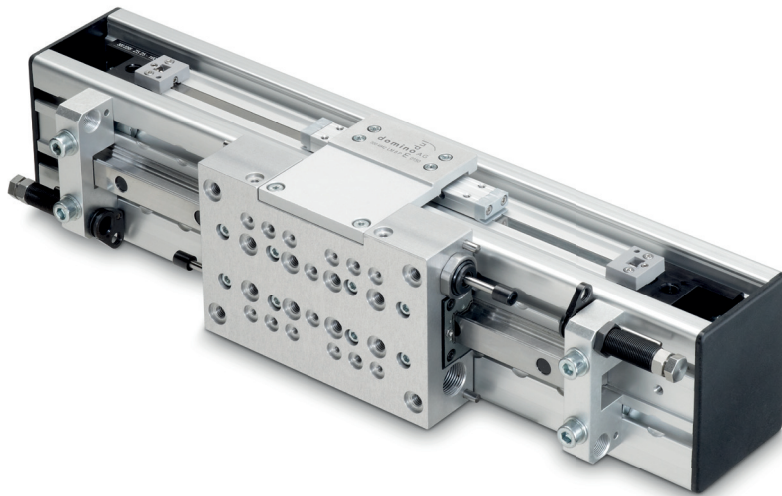

Technische Daten, hubunabhängig | Technical data, stroke-independent

Zylinderdurchmesser	Cylinder diameter	25 mm
theor. Kraft (bei 5 bar) Fa/Fb	Theor. force (at 5 bar) Fa/Fb	245 N/ 245 N
max. Geschwindigkeit	Max. speed	1,2 m/s
Pneumatikanschlüsse	Pneumatic connections	G 1/8"
Medium Druckluft	Medium Compressed-air	trocken gefiltert dry filtered
Betriebsdruckbereich	Operating pressure range	3 – 7 bar
Temperaturbereich	Temperature range	0 – 60°C
Wiederholgenauigkeit	Repeat accuracy	+/-0.02 mm
max. zulässige Masse	Max. permissible mass	8 kg
max. statische Momente	Max. static torques	Ma 400 Nm Mb 400 Nm Mc 192 Nm

Technische Daten, hubabhängig | Technical data, stroke-dependent

Siehe Seite 10 | See page 10

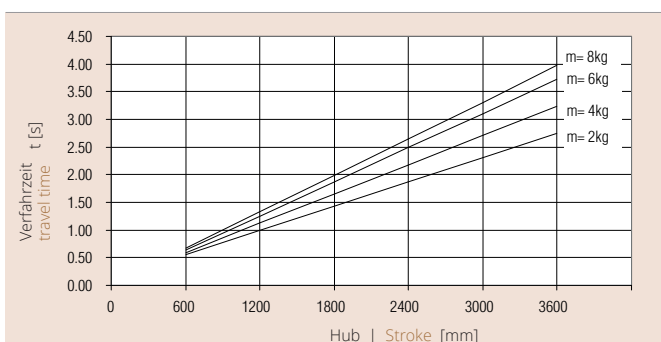
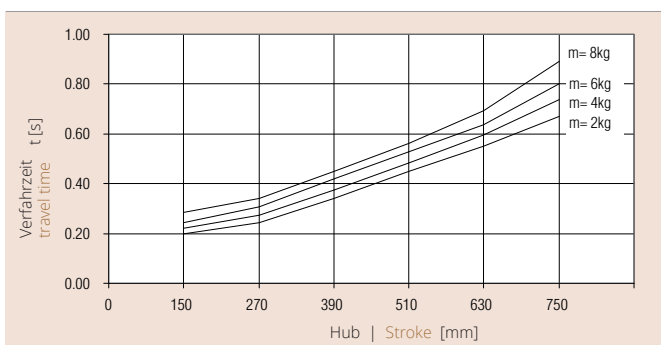

Zulässige Verfahzeit t in Abhängigkeit der Hublänge und der Zusatzmasse m

Die aus dem Diagramm ermittelte Verfahzeit t darf nicht unterschritten werden, diese ist ohne Ventilschaltzeit bei Nenn- druck 6 bar gemessen. Empfehlung: Bei Auslegung der Achse sollte die Verfahzeit t um 20% erhöht angenommen werden.

Permissible travel time t relative to the stroke length and the additional mass m

The travel time t determined from the diagram may not be exceeded this is measured without valve switching time at nominal pressure 6 bar. Recommendation: During the design of the axis, the travel time t should be assumed to be about 20% more.

Linearachsen | Linear Axes

LM 8 P – pneumatische Linearachse | LM 8 P – Pneumatic Linear Axis

Massbild und Pneumatikschema | Dimensional drawing and pneumatic diagram

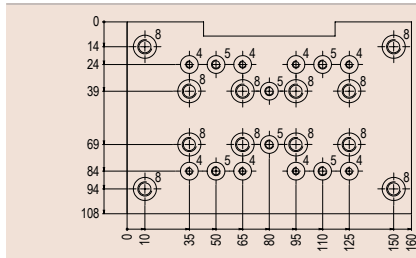
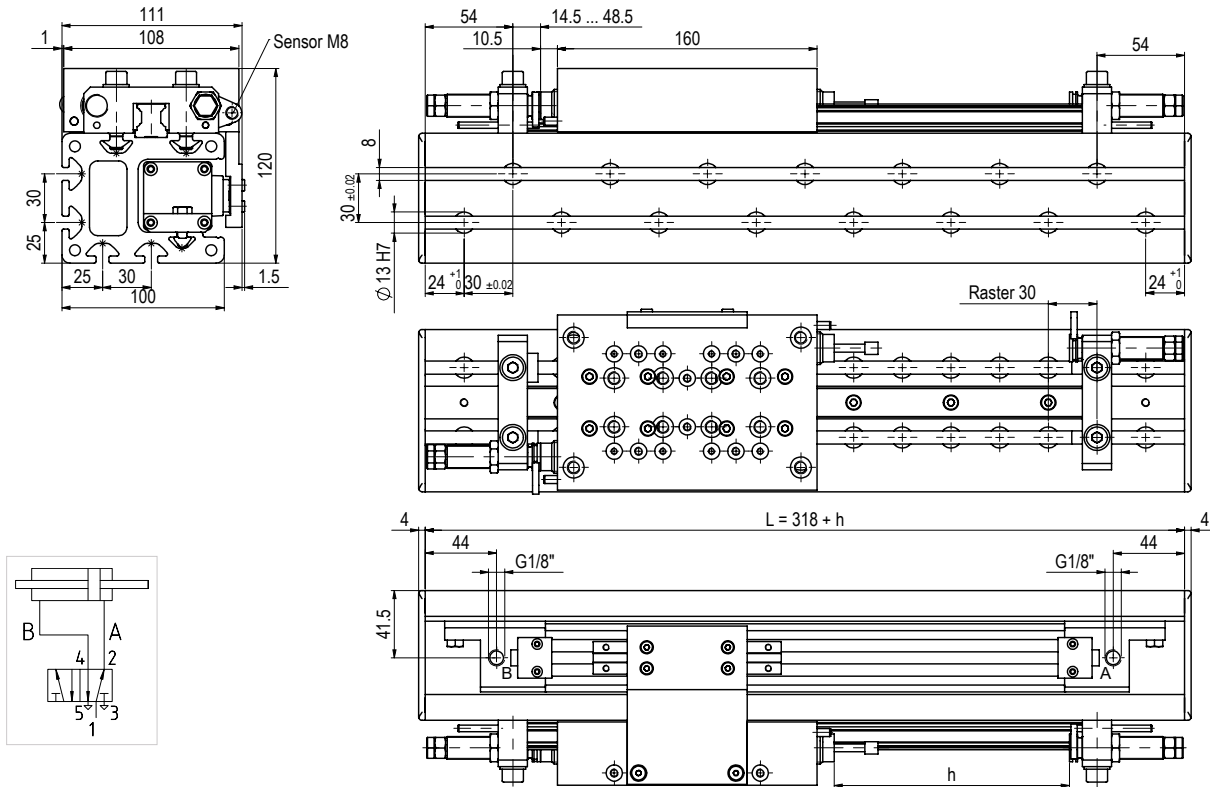

Nr. Zentrierung No.Centering	Gewinde Thread
4 Ø10H7 / 2.1 tief deep	M4
5 Ø10H7 / 2.1 tief deep	M5
8 Ø13H7 / 2.1 tief deep	M8

Lochdistanz +/-0.02 mm
Hole distance +/-0.02 mm

Bezeichnung	Designation	Bestellnr. Order no.
LM 8 P-150		300 4942
LM 8 P-270		300 4943
LM 8 P-390		300 4944
LM 8 P-510		300 4945
LM 8 P-630		300 4946
LM 8 P-750		300 4947
Sonderlänge bis 3660 mm inkl. 2 hydr. Stossdämpfer, 4 Zentrierringe Ø 10, 4 Zentrierringe Ø 13 und 2 Abdeckkappen	Custom length up to 3660 mm Incl. 2 hydr. shock absorbers, 4 centering rings Ø10, 4 centering rings Ø13 and 2 cover caps	
Zubehör	Accessories	
Zentrierring Ø 10	Centering ring Ø10	300 1522
Zentrierring Ø 13	Centering ring Ø13	300 1523
Endschalter M8x1	Limit switch M8x1	300 3174
Stossdämpfer	Shock absorber	300 9320
Energieführungsketten siehe Seite 29	Energy management chains, see page 29	
Zwischenanschlag siehe Seite 30	Intermediate stop, see page 30	